

EMAIL SALES@LANGELIFT.COM FOR ALL MODIFICATION REQUIREMENTS

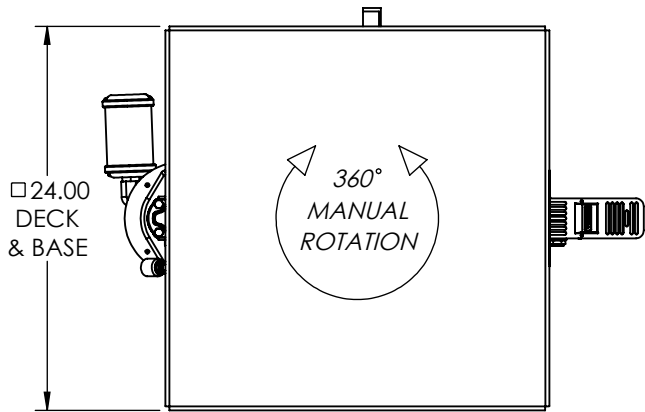

CAPACITY: 5,000 LBS
POWER: AIR MOTOR W/ON BOARD
 REGULATOR, FILTER & LUBRICATOR,
 80PSI @ 50CFM RECOMMENDED
CONTROLS: AIR VALVE PEDAL
PAINT: LANGE LIFT SHADOW GRAY

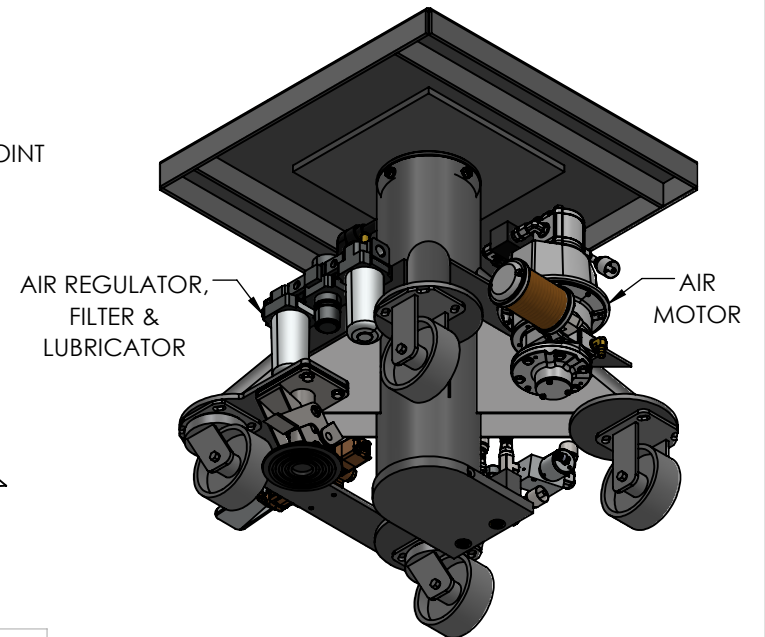
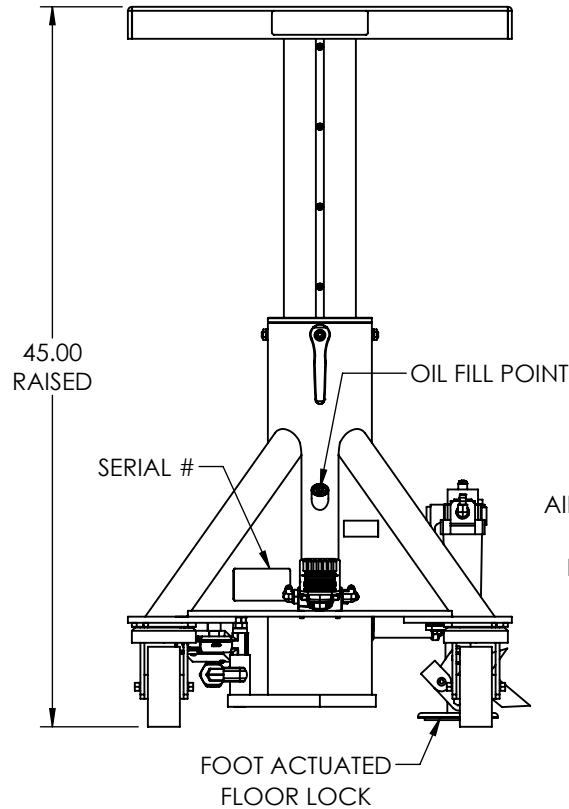
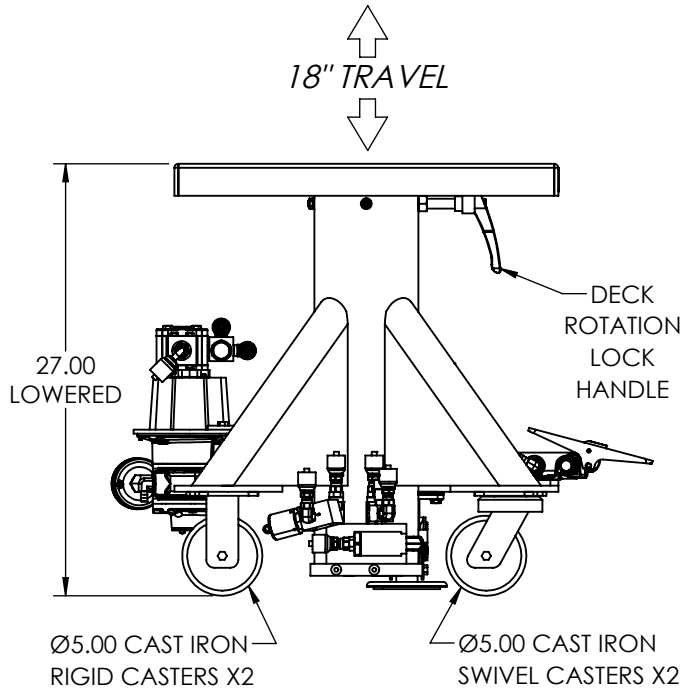
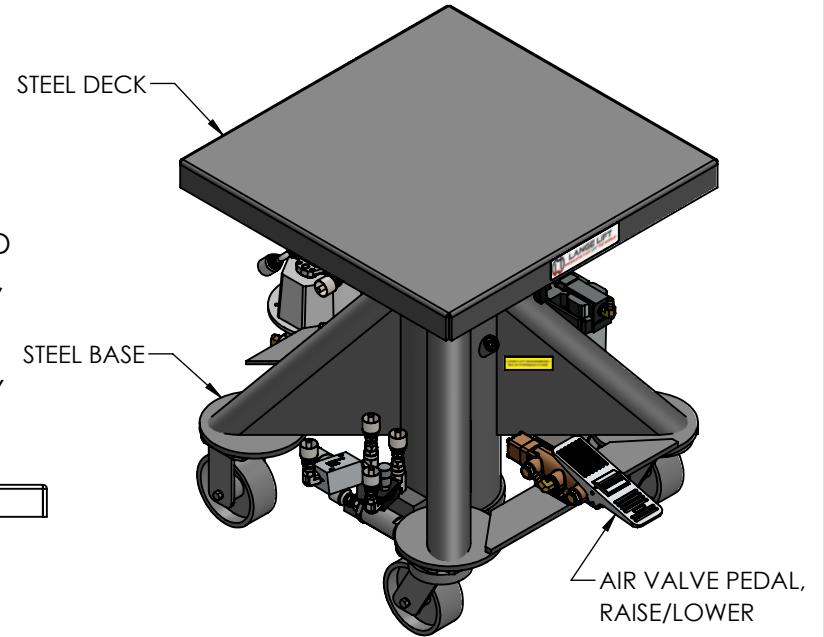

PROPRIETARY AND CONFIDENTIAL, THE INFORMATION CONTAINED
 IN THIS DRAWING IS THE SOLE PROPERTY OF LANGE LIFT. ANY
 REPRODUCTION IN PART OR AS A WHOLE WITHOUT THE WRITTEN
 PERMISSION OF LANGE LIFT IS PROHIBITED.



DIMENSIONS ARE IN INCHES THIRD ANGLE PROJECTION		DESCRIPTION: 5K LB CAPACITY, 24" DECK, AIR POWER			REV: -
SCALE: NTS	DRAWN BY: DBK	DATE: 4/18/2023	DWG NO: L-524-AP	SHEET: 1 OF 1	