

EMAIL SALES@LANGELIFT.COM FOR ALL MODIFICATION REQUIREMENTS

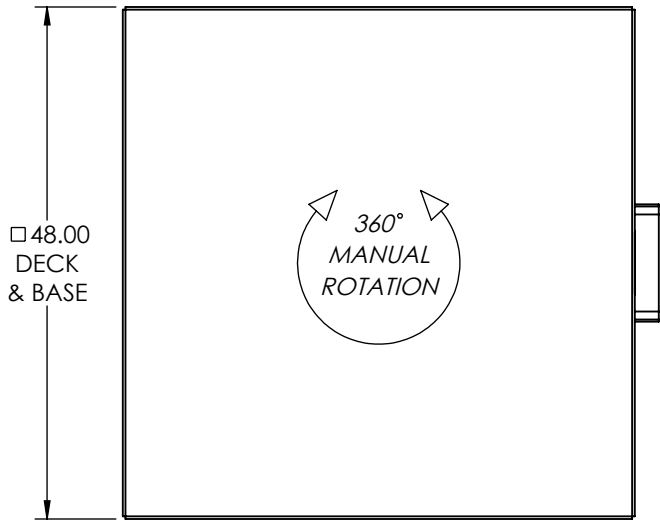

CAPACITY: 4,000 LBS
POWER: 120V AC ELECTRIC OVER HYDRAULIC MOTOR WITH ELECTRICAL BOX & RECEPTACLE
CONTROLS: DUAL FOOT SWITCH
PAINT: LANGE LIFT SHADOW GRAY

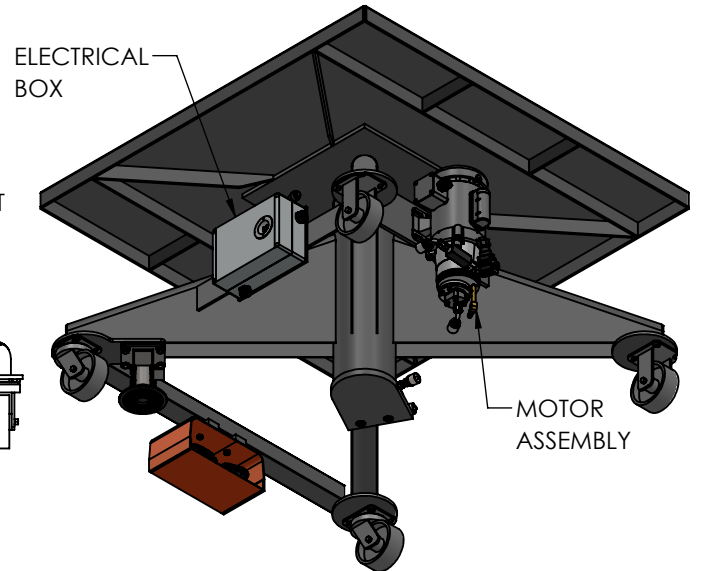
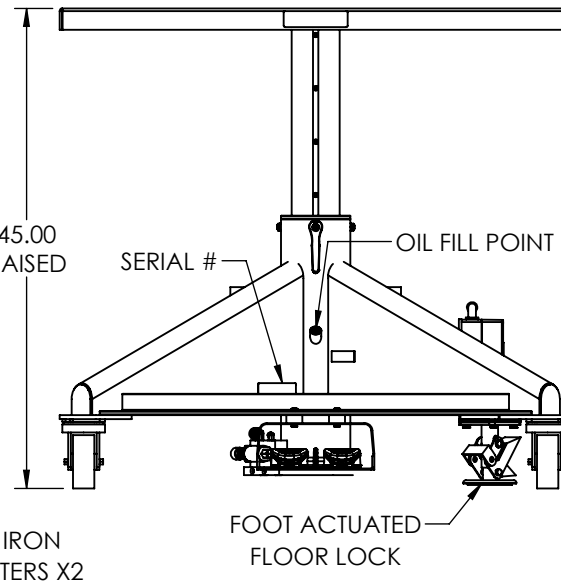
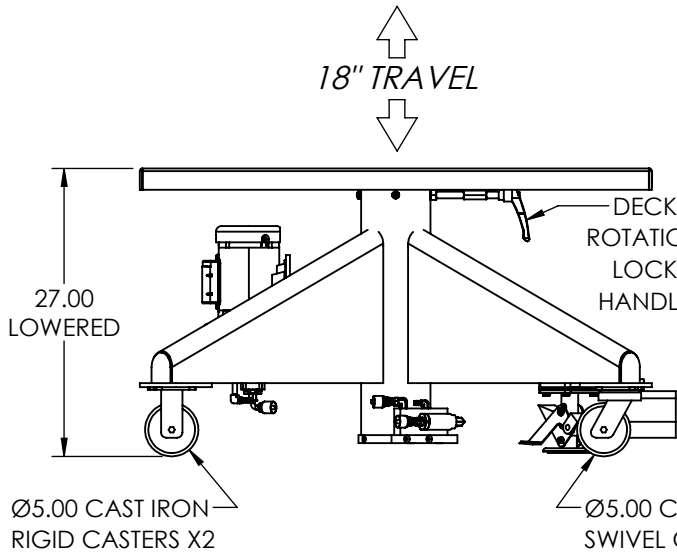
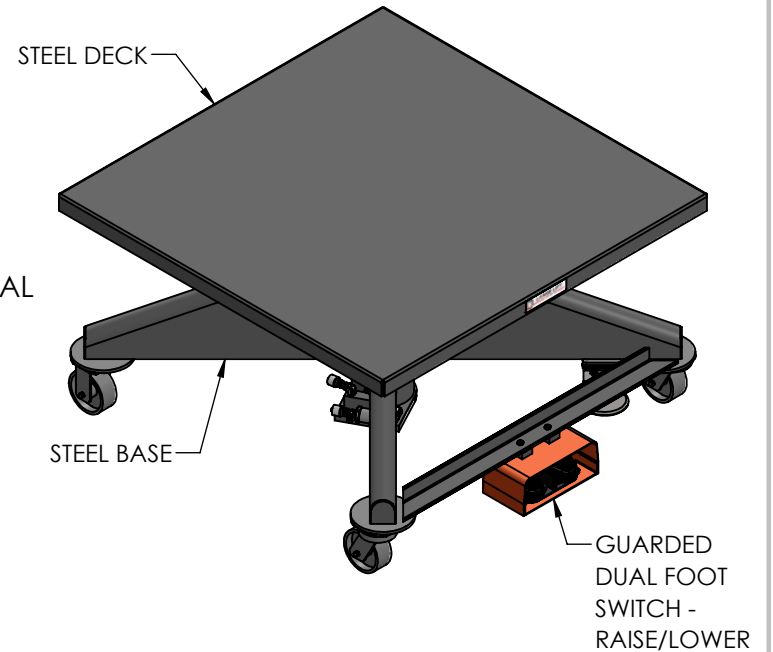

PROPRIETARY AND CONFIDENTIAL, THE INFORMATION CONTAINED IN THIS DRAWING IS THE SOLE PROPERTY OF LANGE LIFT. ANY REPRODUCTION IN PART OR AS A WHOLE WITHOUT THE WRITTEN PERMISSION OF LANGE LIFT IS PROHIBITED.



DIMENSIONS ARE IN INCHES		DESCRIPTION:		REV:
THIRD ANGLE PROJECTION		4K LB CAPACITY, 48" DECK, ELECTRIC POWER		-
SCALE:	DRAWN BY:	DATE:	DWG NO:	SHEET:
NTS	DBK	4/19/2023	L-448-EP	1 OF 1