

EMAIL SALES@LANGELIFT.COM FOR ALL MODIFICATION REQUIREMENTS

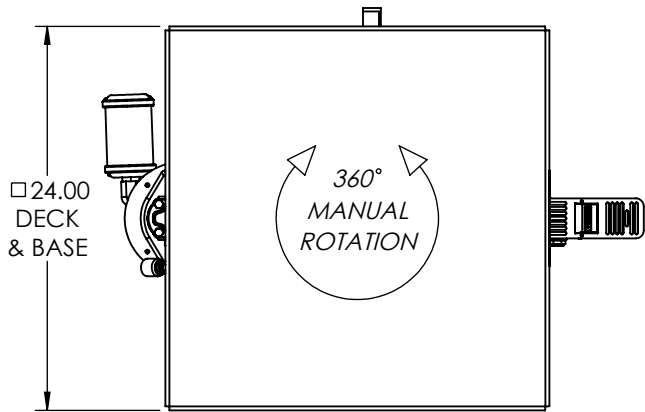

CAPACITY: 4,000 LBS
POWER: AIR MOTOR W/ON BOARD REGULATOR, FILTER & LUBRICATOR, 80PSI @ 50CFM RECOMMENDED
CONTROLS: AIR VALVE PEDAL
PAINT: LANGE LIFT SHADOW GRAY

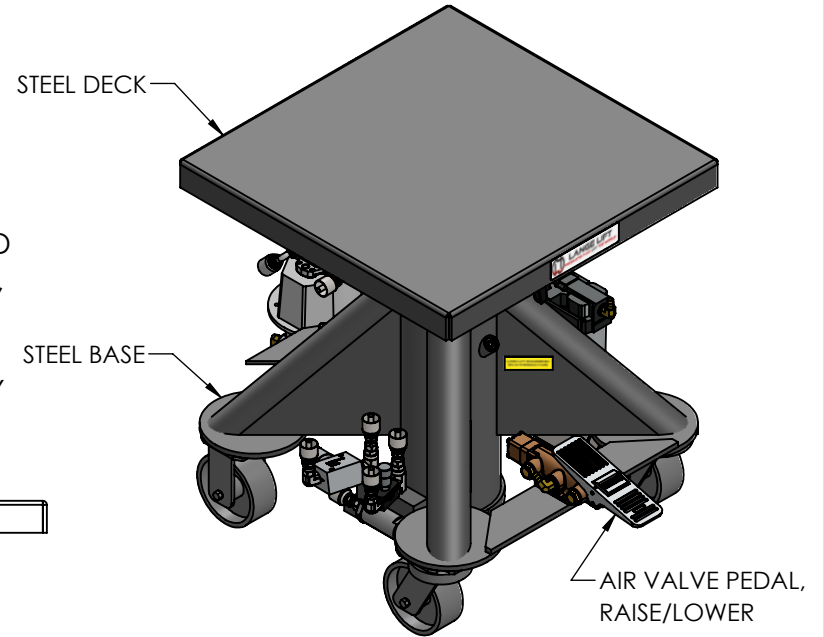

↑
18" TRAVEL
↓

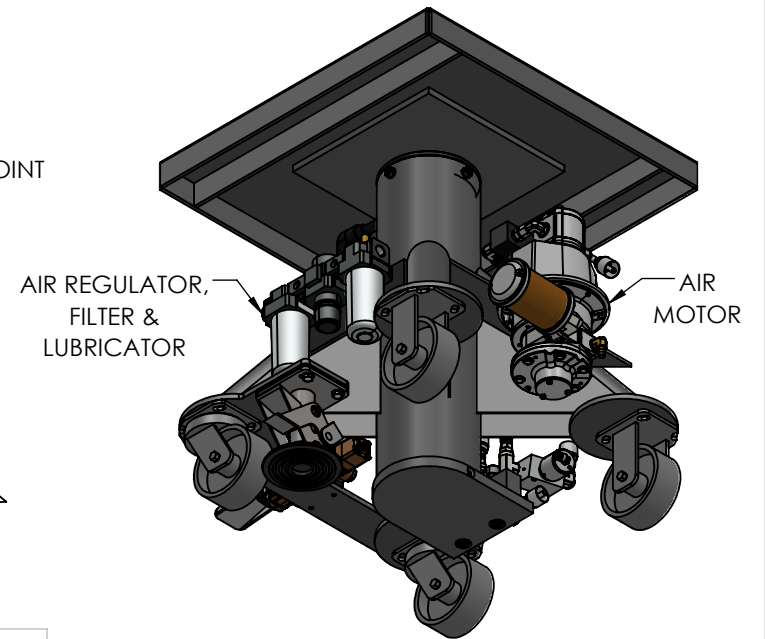
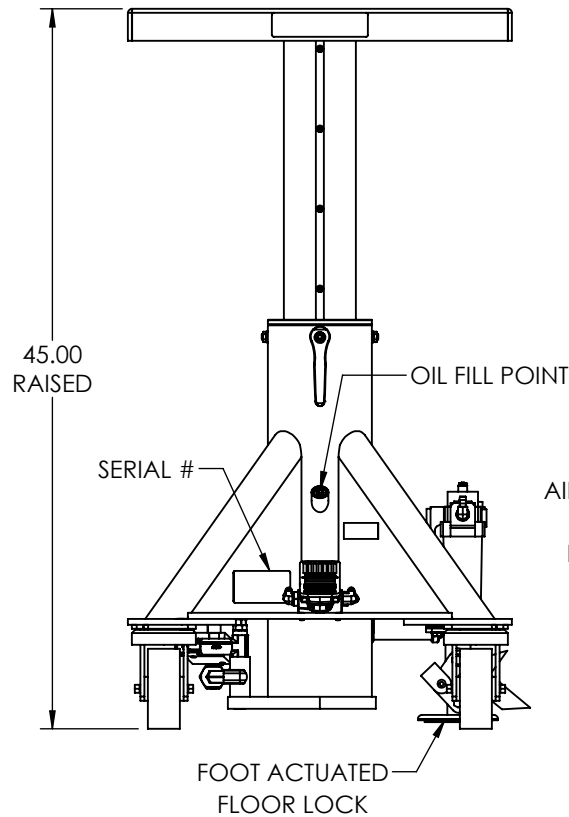
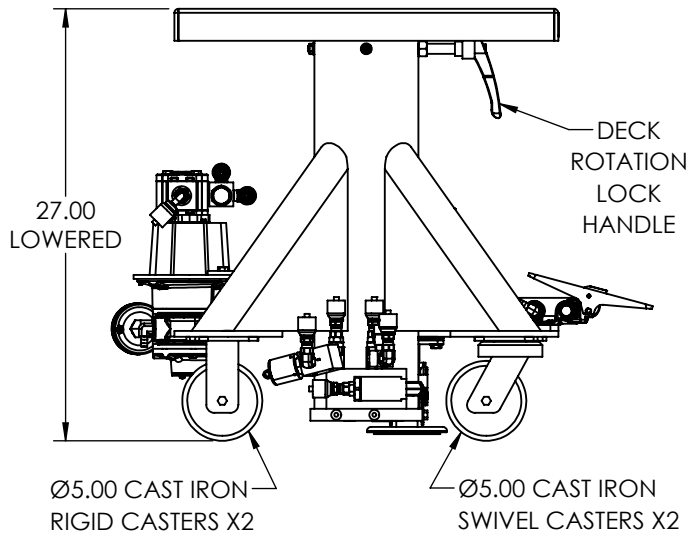

PROPRIETARY AND CONFIDENTIAL, THE INFORMATION CONTAINED IN THIS DRAWING IS THE SOLE PROPERTY OF LANGE LIFT. ANY REPRODUCTION IN PART OR AS A WHOLE WITHOUT THE WRITTEN PERMISSION OF LANGE LIFT IS PROHIBITED.



DIMENSIONS ARE IN INCHES		THIRD ANGLE PROJECTION		DESCRIPTION:		REV:
				4K LB CAPACITY, 24" DECK, AIR POWER		-
SCALE:	DRAWN BY:	DATE:	DWG NO:	SHEET:		
NTS	DBK	4/19/2023	L-424-AP	1 OF 1		