

EMAIL SALES@LANGELIFT.COM FOR ALL MODIFICATION REQUIREMENTS

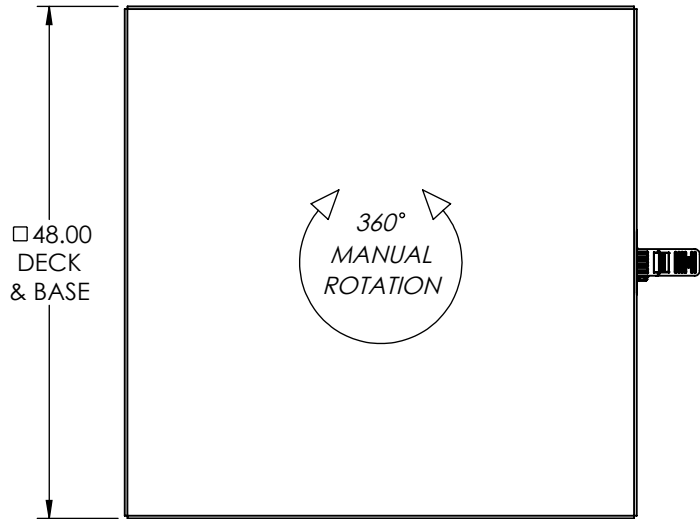

CAPACITY: 3,000 LBS
POWER: AIR MOTOR W/ON BOARD
 REGULATOR, FILTER & LUBRICATOR,
 80PSI @ 50CFM RECOMMENDED
CONTROLS: AIR VALVE PEDAL
PAINT: LANGE LIFT SHADOW GRAY

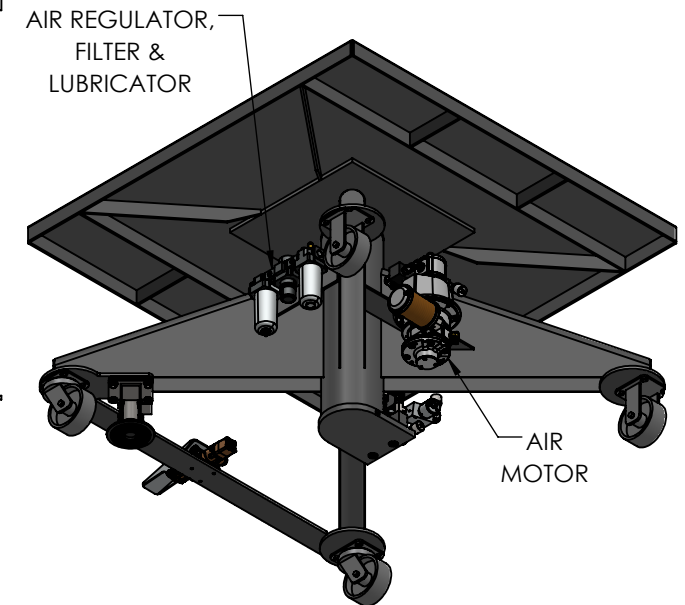
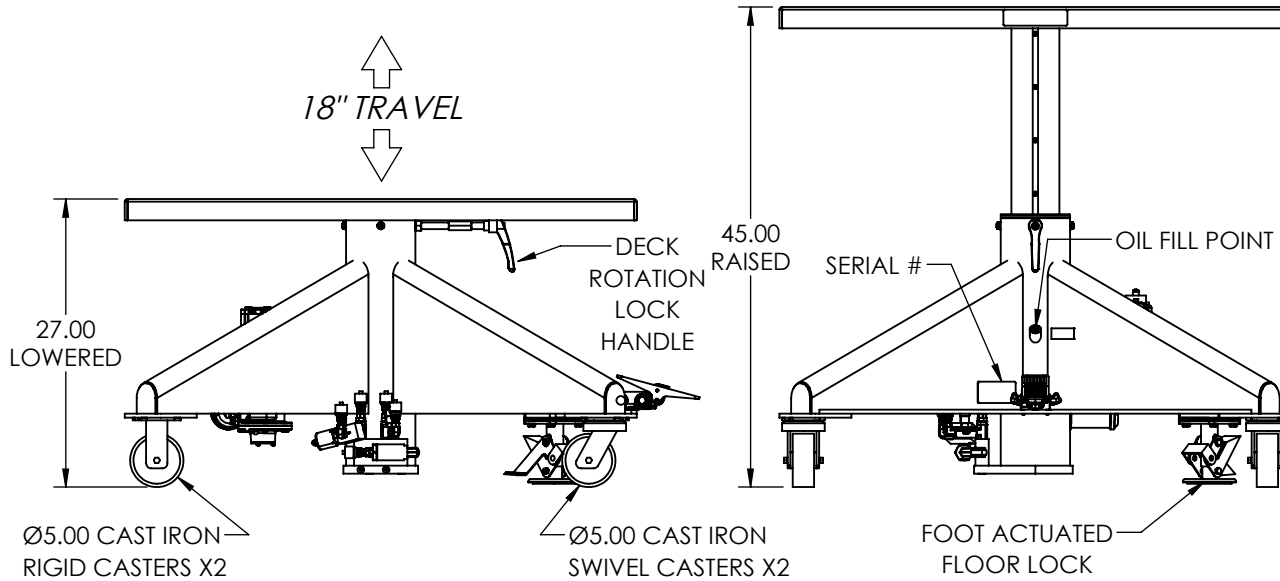
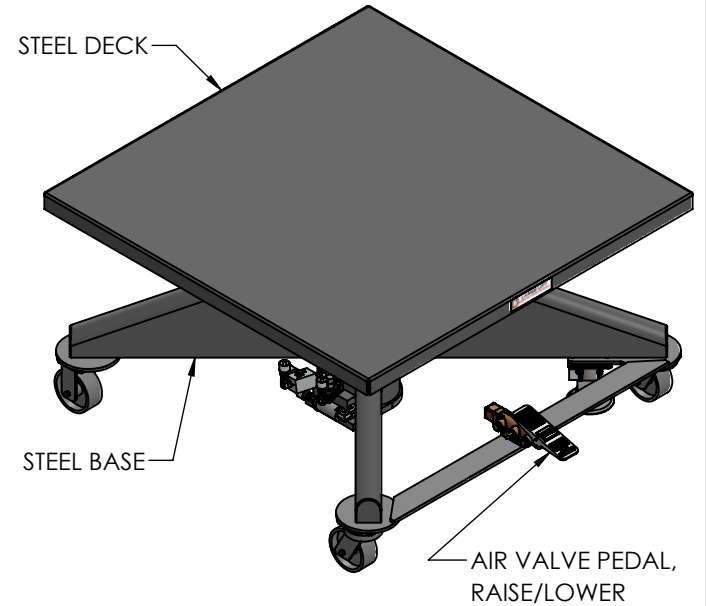

PROPRIETARY AND CONFIDENTIAL, THE INFORMATION CONTAINED
 IN THIS DRAWING IS THE SOLE PROPERTY OF LANGE LIFT. ANY
 REPRODUCTION IN PART OR AS A WHOLE WITHOUT THE WRITTEN
 PERMISSION OF LANGE LIFT IS PROHIBITED.



DIMENSIONS ARE IN INCHES		THIRD ANGLE PROJECTION		DESCRIPTION:		REV:
				3K LB CAPACITY, 48" DECK, AIR POWER		-
SCALE:	DRAWN BY:	DATE:	DWG NO:	SHEET:		
NTS	DBK	4/19/2023	L-348-AP	1 OF 1		