

EMAIL SALES@LANGELIFT.COM FOR ALL MODIFICATION REQUIREMENTS

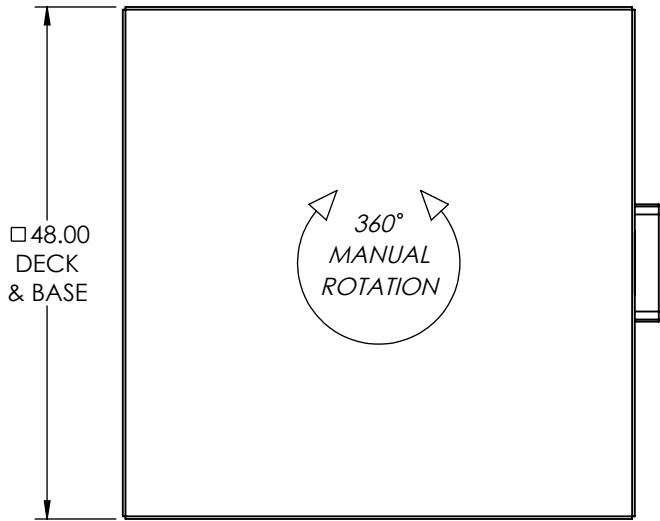

**CAPACITY:** 2,000 LBS  
**POWER:** 120V AC ELECTRIC OVER HYDRAULIC MOTOR WITH ELECTRICAL BOX & RECEPTACLE  
**CONTROLS:** DUAL FOOT SWITCH  
**PAINT:** LANGE LIFT SHADOW GRAY

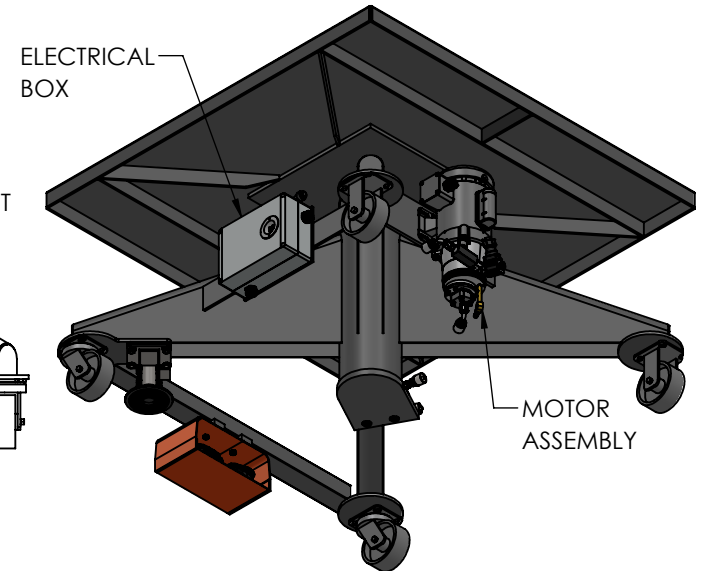
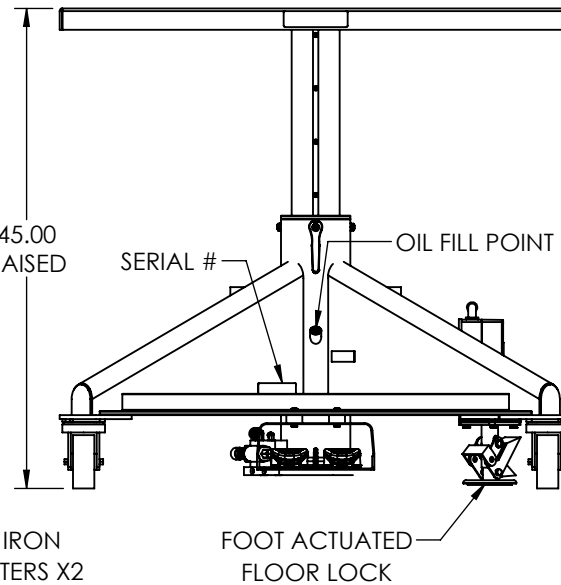
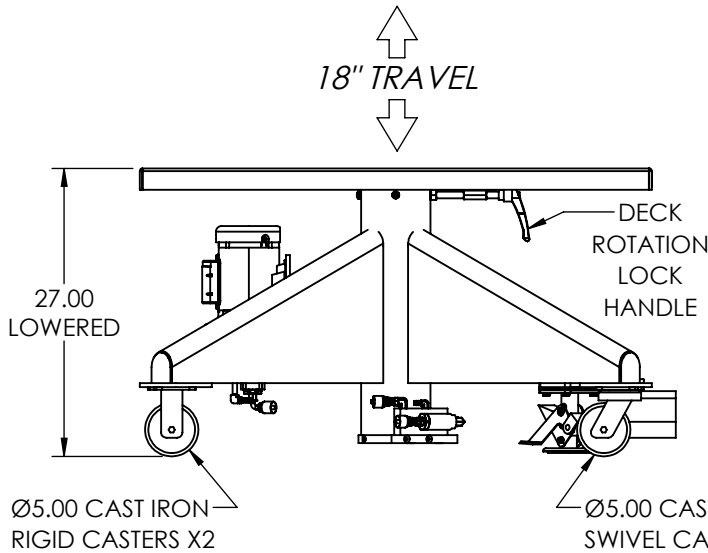
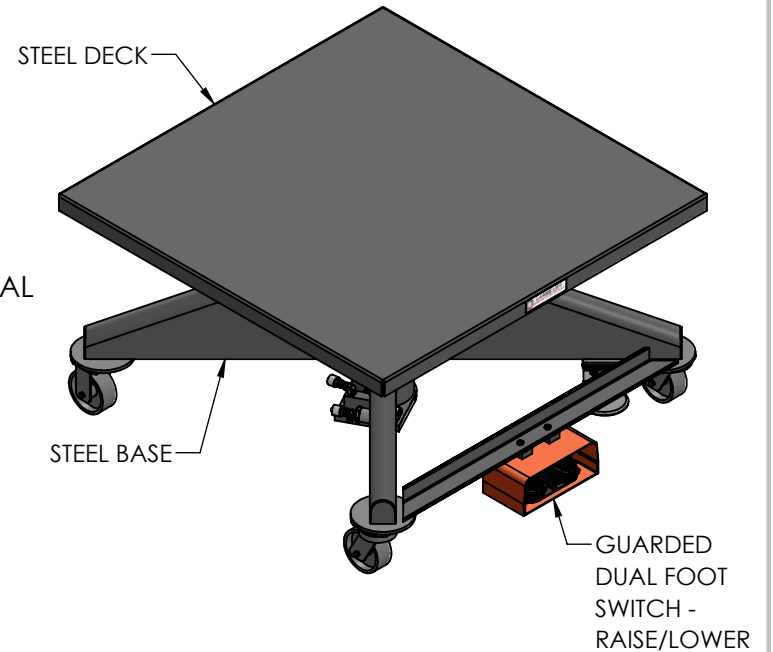

PROPRIETARY AND CONFIDENTIAL, THE INFORMATION CONTAINED IN THIS DRAWING IS THE SOLE PROPERTY OF LANGE LIFT. ANY REPRODUCTION IN PART OR AS A WHOLE WITHOUT THE WRITTEN PERMISSION OF LANGE LIFT IS PROHIBITED.



DIMENSIONS ARE IN INCHES		DESCRIPTION:		REV:
THIRD ANGLE PROJECTION		<b>2K LB CAPACITY, 48" DECK, ELECTRIC POWER</b>		-
SCALE:	DRAWN BY:	DATE:	DWG NO:	SHEET:
NTS	DBK	4/18/2023	<b>L-248-EP</b>	1 OF 1