

EMAIL SALES@LANGELIFT.COM FOR ALL MODIFICATION REQUIREMENTS

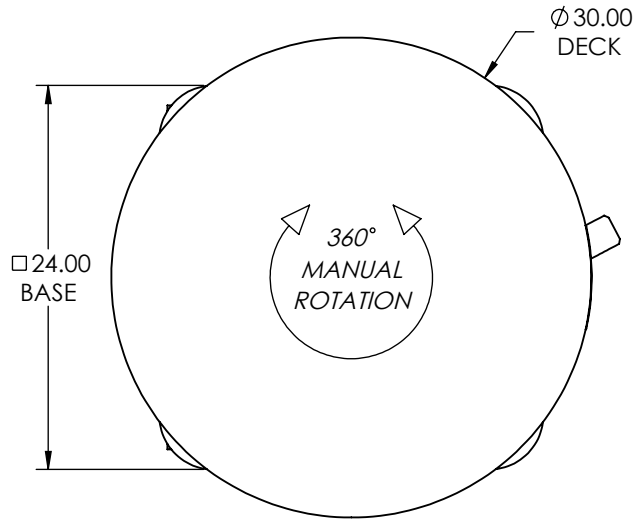

**CAPACITY:** 2,000 LBS  
**POWER:** MANUAL  
**CONTROLS:** FOOT PEDALS  
**PAINT:** LANGE LIFT SHADOW GRAY

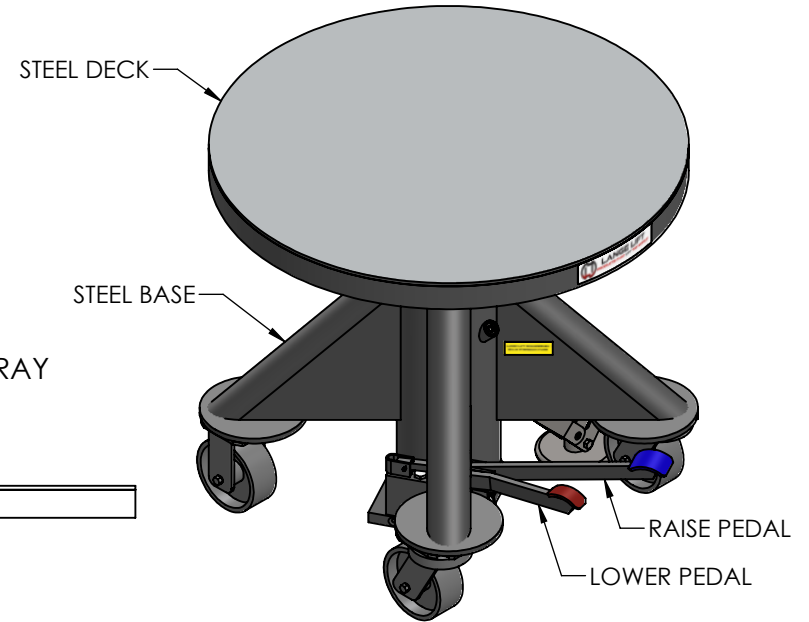

18" TRAVEL

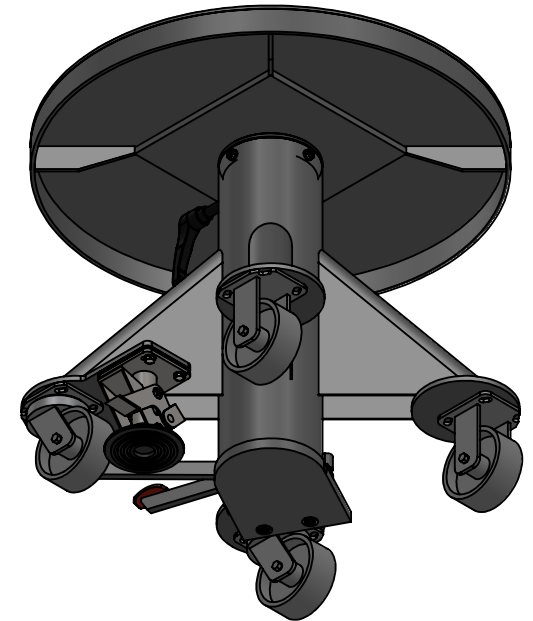
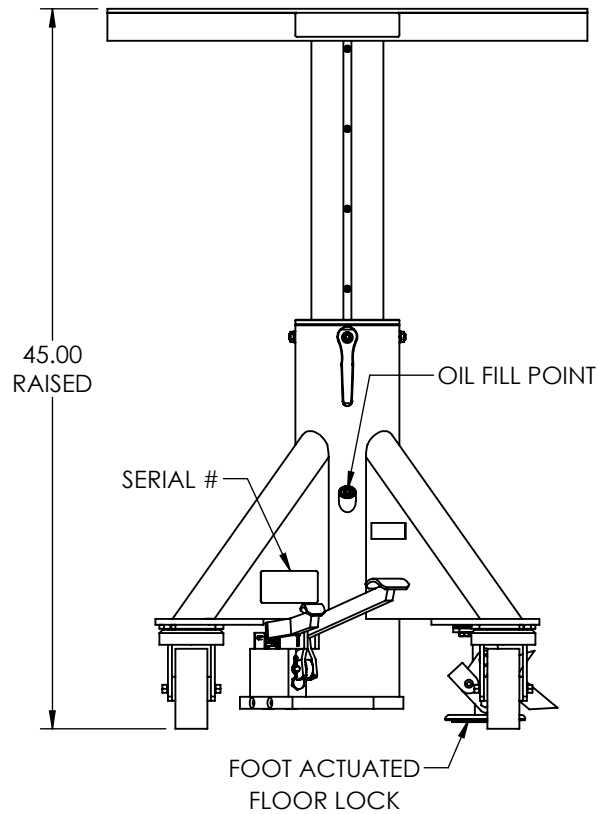
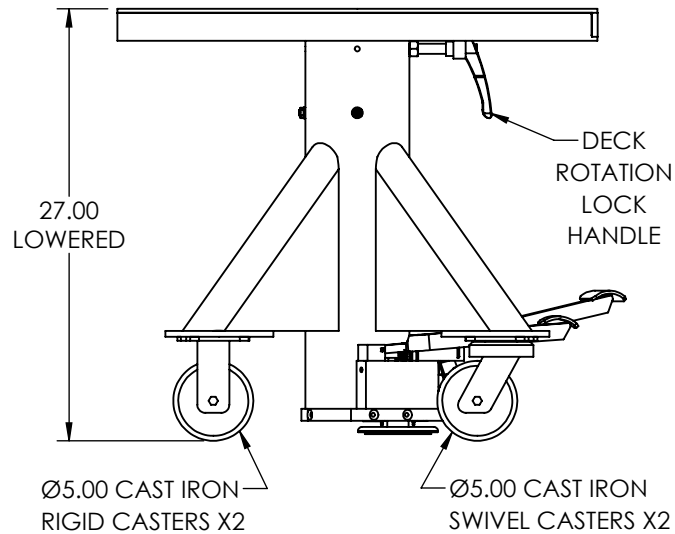

PROPRIETARY AND CONFIDENTIAL, THE INFORMATION CONTAINED IN THIS DRAWING IS THE SOLE PROPERTY OF LANGE LIFT. ANY REPRODUCTION IN PART OR AS A WHOLE WITHOUT THE WRITTEN PERMISSION OF LANGE LIFT IS PROHIBITED.



DIMENSIONS ARE IN INCHES		DESCRIPTION:		REV:
THIRD ANGLE PROJECTION		2K LB CAPACITY, Ø30" DECK, MANUAL POWER		-
SCALE:	DRAWN BY:	DATE:	DWG NO:	SHEET:
NTS	DBK	11/18/2022	L-224-30RD	1 OF 1