

EMAIL SALES@LANGELIFT.COM FOR ALL MODIFICATION REQUIREMENTS

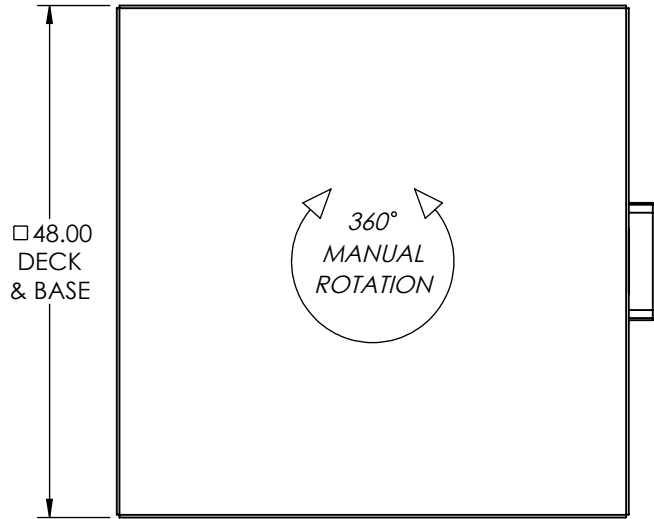

CAPACITY: 1,000 LBS
POWER: 120V AC ELECTRIC OVER
 HYDRAULIC MOTOR WITH ELECTRICAL
 BOX & RECEPTACLE
CONTROLS: DUAL FOOT SWITCH
PAINT: LANGE LIFT SHADOW GRAY

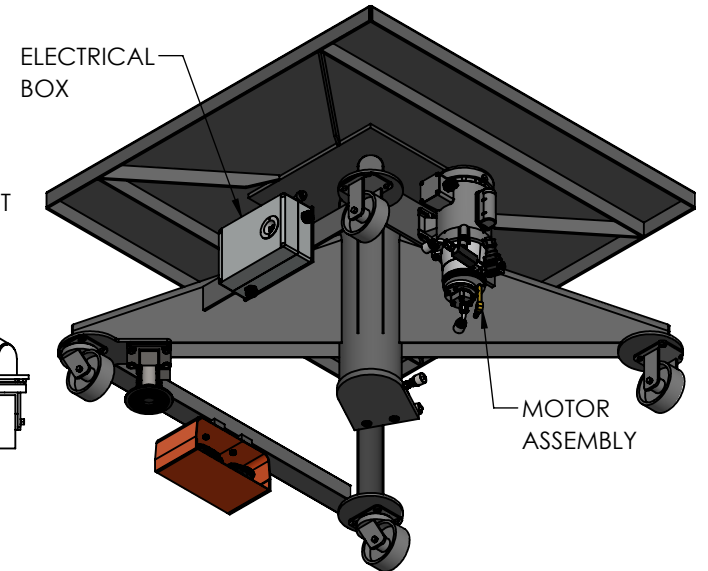
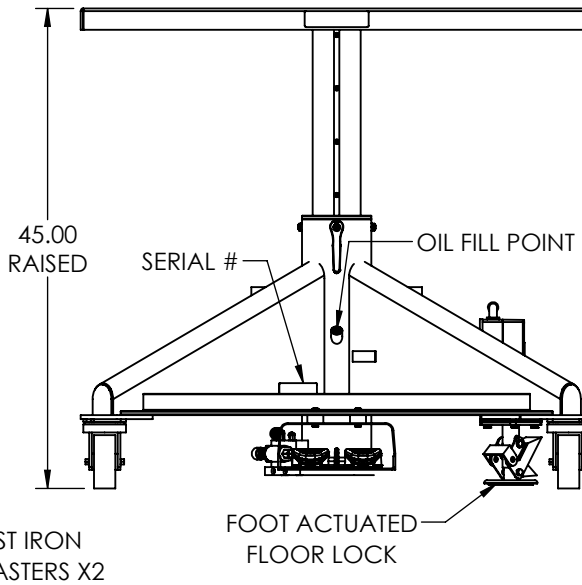
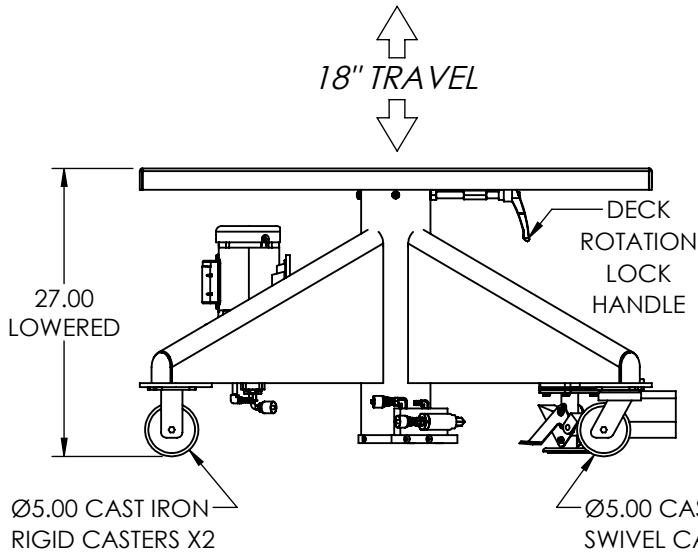
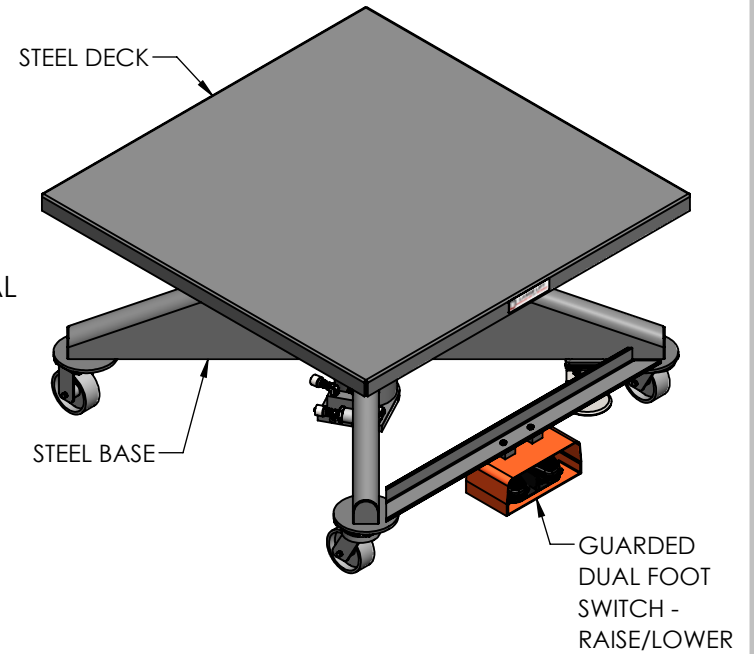

PROPRIETARY AND CONFIDENTIAL, THE INFORMATION CONTAINED
 IN THIS DRAWING IS THE SOLE PROPERTY OF LANGE LIFT. ANY
 REPRODUCTION IN PART OR AS A WHOLE WITHOUT THE WRITTEN
 PERMISSION OF LANGE LIFT IS PROHIBITED.



DIMENSIONS ARE IN INCHES		DESCRIPTION:		REV:
THIRD ANGLE PROJECTION		1K LB CAPACITY, 48" DECK, ELECTRIC POWER		-
SCALE:	DRAWN BY:	DATE:	DWG NO:	SHEET:
NTS	DBK	11/18/2022	L-148-EP	1 OF 1