

EMAIL SALES@LANGELIFT.COM FOR ALL MODIFICATION REQUIREMENTS

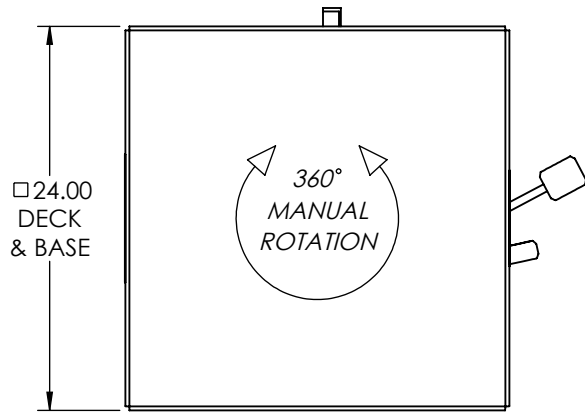

CAPACITY: 1,000 LBS
POWER: MANUAL
CONTROLS: FOOT PEDALS
PAINT: LANGE LIFT SHADOW GRAY

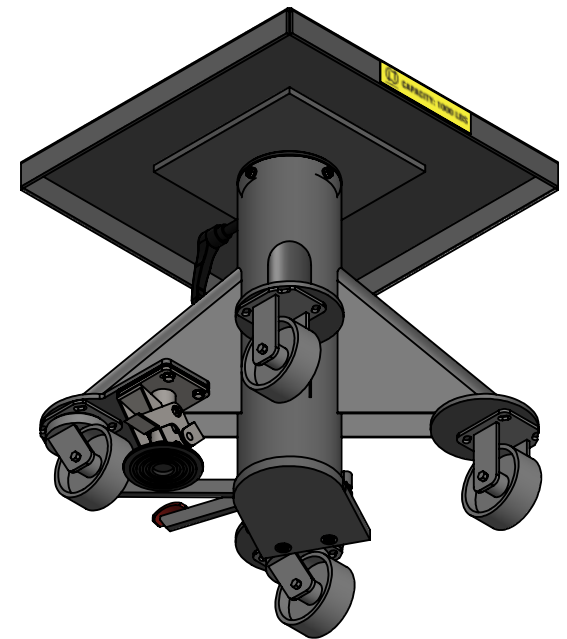
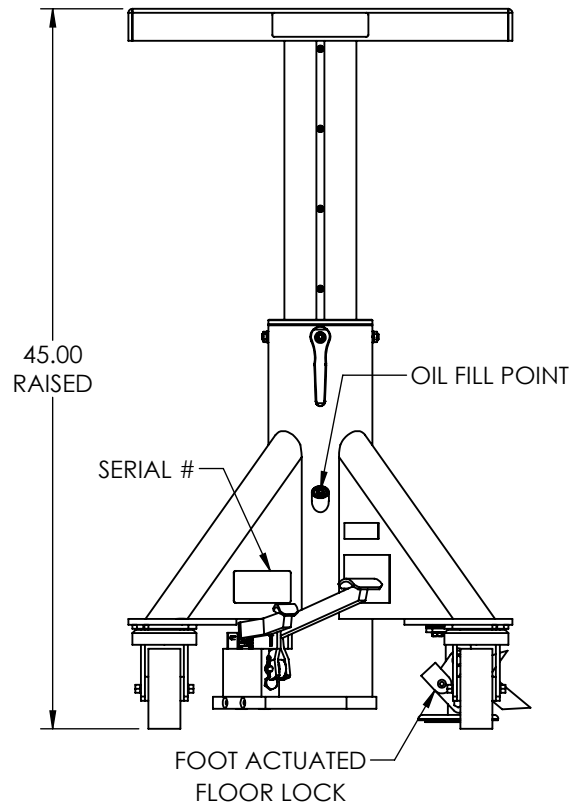
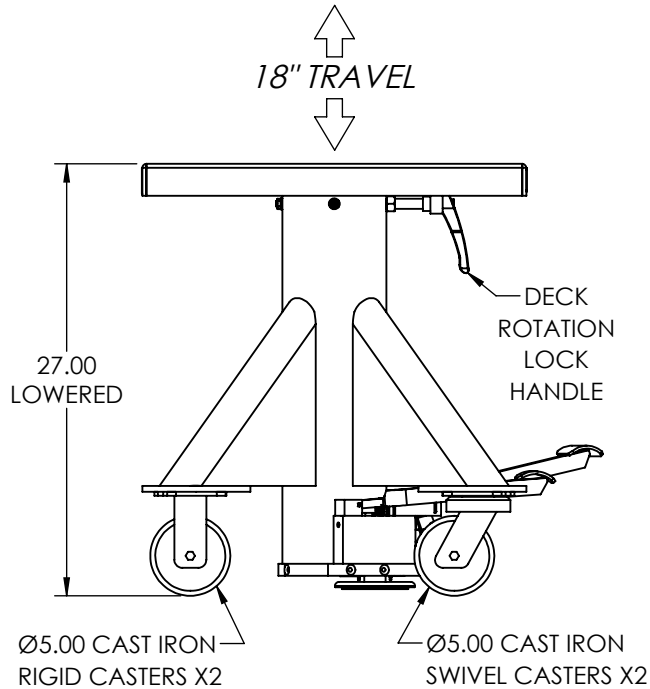
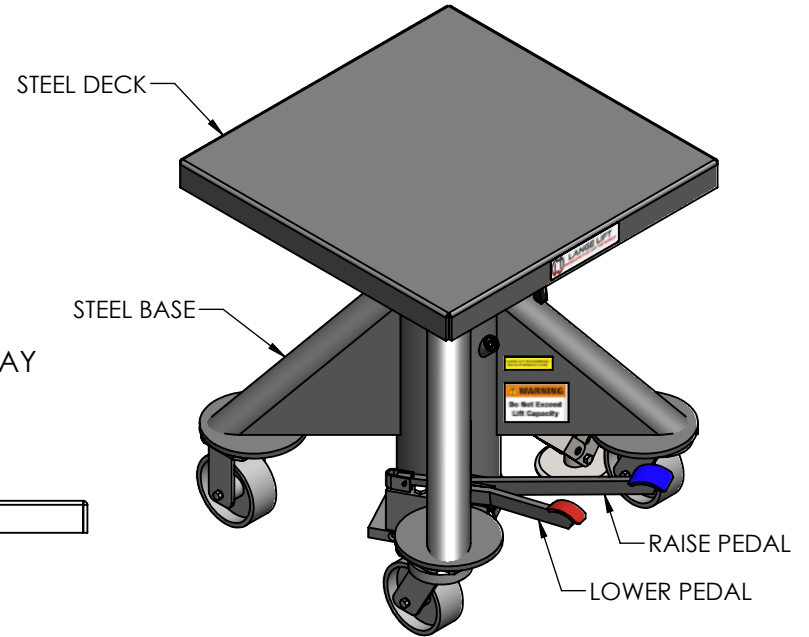

PROPRIETARY AND CONFIDENTIAL, THE INFORMATION CONTAINED IN THIS DRAWING IS THE SOLE PROPERTY OF LANGE LIFT. ANY REPRODUCTION IN PART OR AS A WHOLE WITHOUT THE WRITTEN PERMISSION OF LANGE LIFT IS PROHIBITED.



DIMENSIONS ARE IN INCHES		DESCRIPTION:		REV:
THIRD ANGLE PROJECTION		1K LB CAPACITY, 24" DECK, MANUAL POWER		-
SCALE:	DRAWN BY:	DATE:	DWG NO:	SHEET:
NTS	DBK	11/18/2022	L-124	1 OF 1